

3-3
1:10

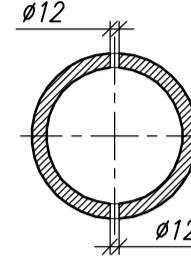

2-2
1:10

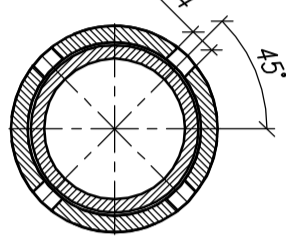

1-1
1:10

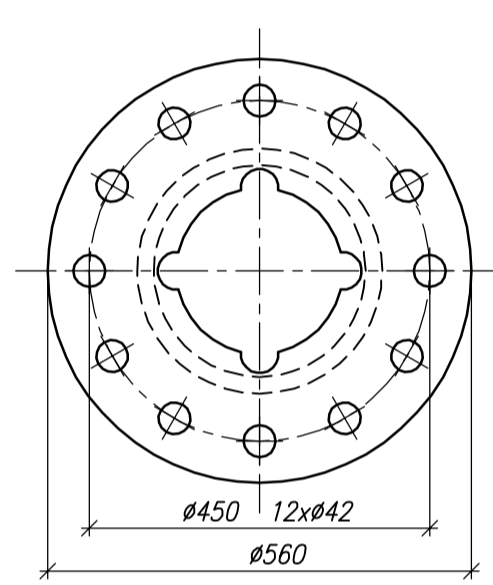

Attention!

- 1) Material: S355J2+N/S235JR+N acc to PN EN 10025-2
- 2) Construction zinc galvanized acc. to PN-EN ISO 1461.
- 3) The structure may be changed from technological reasons.

C	-	-	-
B	-	-	-
A	-	-	-
Revision	Changed item	Date	Name
 EuroPoles Kromiss Sp. z o.o. 42-202 Częstochowa, ul. Legionów 92 tel./fax. +48 34 360 24 00		Index: WE-RYG8 Title: Traction Lightning Pole KRO/Rp-30/9,9/0,0	
Object:	Ryga	Name	Construction licence no.
	-	Designer	-
	-	Asst. designer	mgr inż. A.Grabowski
	-	Reviewer	-
Sheet:	Scale:	Drawing no.:	Revision:
A3	1:20	13.240.11.A.P	-

Wszelkie prawa autorskie do niniejszego rysunku i związanych z nim projektów są zastrzeżone dla firmy EUROPOLES KROMISS Sp. z o.o. Zabronione jest kopiowanie lub reprodukcja bez zgody firmy EUROPOLES KROMISS Sp. z o.o. oraz udostępnianie osobom trzecim, jest zabronione.